

BI4U-EM12WD-AP6X-H1141

Inductive Sensor – For the Food Industry

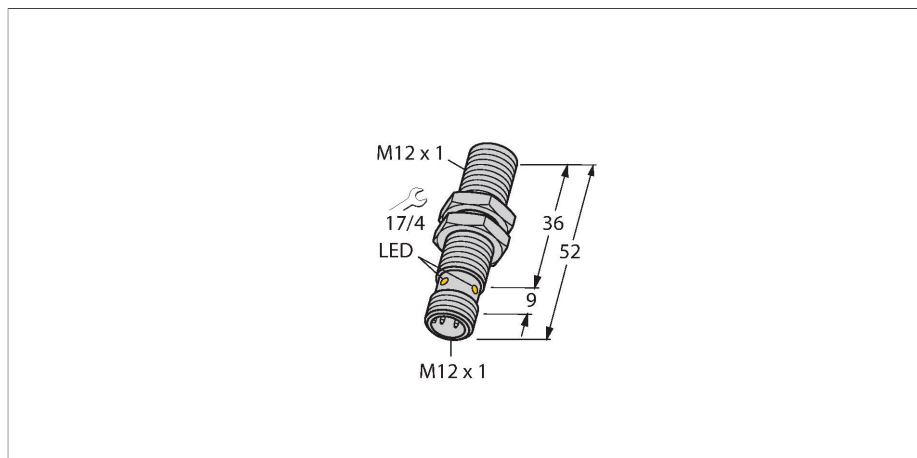

Features

- Threaded barrel, M12 x 1
- Stainless steel, 1.4404
- Front cap made of liquid crystal polymer
- Factor 1 for all metals
- Resistant to magnetic fields
- For temperatures of -40 °C...+100 °C
- High protection class IP69K for harsh environments
- Special double-lip seal
- Protection against all common acidic and alkaline cleaning agents
- Laser engraved label, permanently legible
- DC 3-wire, 10...30 VDC
- NO contact, PNP output
- M12 x 1 male connector

Technical data

Type	BI4U-EM12WD-AP6X-H1141
ID	1634812
General data	
Rated switching distance	4 mm
Mounting conditions	Flush
Secured operating distance	$\leq (0.81 \times S_n)$ mm
Repeat accuracy	≤ 2 % of full scale
Temperature drift	$\leq \pm 10$ %
	$\leq \pm 20$ %, ≤ -25 °C , $\geq +70$ °C
Hysteresis	3...15 %
Electrical data	
Operating voltage	10...30 VDC
Residual ripple	≤ 10 % U_{ss}
DC rated operational current	≤ 200 mA
No-load current	25 mA
Residual current	≤ 0.1 mA
Isolation test voltage	≤ 0.5 kV
Short-circuit protection	yes / Cyclic
Voltage drop at I_e	≤ 1.8 V
Wire breakage/Reverse polarity protection	yes / Complete
Output function	3-wire, NO contact, PNP
DC field stability	300 mT
AC field stability	300 mT _{ss}
Insulation class	□
Switching frequency	3 kHz

Wiring diagram

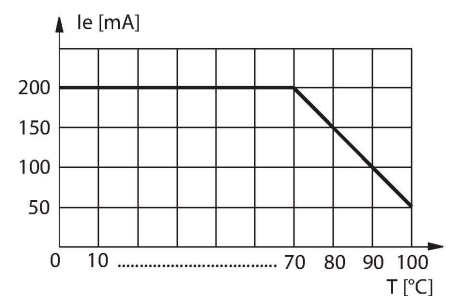
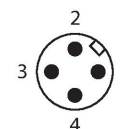
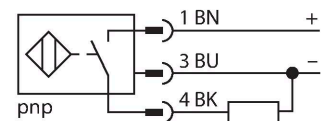

Technical data

Mechanical data	
Design	Threaded barrel, M12 x 1
Dimensions	52 mm
Housing material	Stainless steel, 1.4404 (AISI 316L)
Active area material	Plastic, LCP
Connector housing	plastic, PP
Admissible pressure on front cap	≤ 20 bar
Max. tightening torque of housing nut	10 Nm
Electrical connection	Connector, M12 × 1
Environmental conditions	
Ambient temperature	-40...+100 °C
Vibration resistance	55 Hz (1 mm)
Shock resistance	30 g (11 ms)
Protection class	IP68 IP69K
MTTF	874 years acc. to SN 29500 (Ed. 99) 40 °C
Switching state	LED, Yellow

Mounting instructions

Mounting instructions/Description

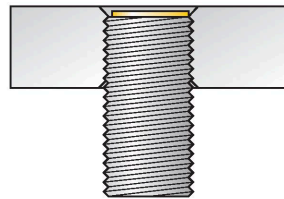

Distance D	24 mm
Distance W	3 x Sn
Distance T	3 x B
Distance S	1.5 x B
Distance G	6 x Sn
Diameter active area B	Ø 12 mm

All flush mountable uprox+ threaded barrel types are also recessed mountable. Safe operation is ensured if the sensor is screwed in by half a turn.

Accessories

MW-12 **6945003**
 Mounting bracket for threaded barrel sensors; material: Stainless steel A2 1.4301 (AISI 304)

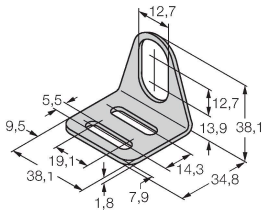

BSS-12 **6901321**
 Mounting clamp for smooth and threaded barrel sensors; material: Polypropylene

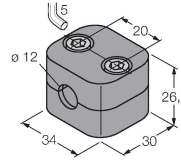

PN-M12 **6905309**
 Impact protection nut for M12x1 threaded barrel devices; material: Stainless steel A2 1.4305 (AISI 303)

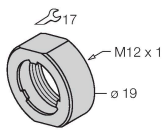

Accessories

Dimension drawing	Type	ID	
	RKH4-2/TFE	6935482	Connection cable, M12 female, straight, 3-pin, stainless steel coupling nut, cable length: 2 m, jacket material: PVC, gray temperature range -25...+80 °C; other cable lengths and designs available, see www.turck.com
	RKH4-2/TFG	6934384	Connection cable, M12 female, straight, 3-pin, stainless steel coupling nut, cable length: 2 m, jacket material: TPE, gray temperature range -40...+105 °C; other cable lengths and designs available, see www.turck.com